

SPARTAN LED Zone 2/22 SPZ Mid Power Floodlight

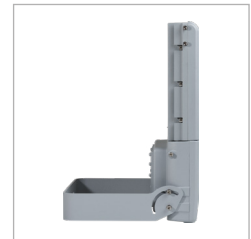

rayTEC®



Power / Performance

High lumen output up to 16,470 lumens, designed to directly replace traditional discharge light sources up to 250W SON.



Robust and Durable

Robust and durable construction from marine grade aluminium and with a wide operating temperature for even the most challenging conditions.



Intelligent Emergency

Self-testing emergency battery providing up to 3 hours emergency back-up.



Multiple Beam Angles

Available with a range of beam patterns to effectively light up large open areas. The use of secondary optics means no loss of output on wider angles.

5 YEAR WARRANTY

All Raytec luminaires are provided with an industry leading 5 year warranty and have an expected useful life in excess of 10 years. See Warranty Statement for details.



Technical Specifications

Certification

| | |
|-----------------------|---|
| Hazardous Area Rating | ATEX, UKEX and IEC Ex rated for Gas and Dust |
| Certificates | CML21ATEX3320 & IEC Ex CML21.0038 or CML21UKEX3321 |
| Gas | II 3 G D Ex ec mc IIC T4 Gc Ta= -40°C to +60°C (-20°C to +50°C emergency variants) |
| Dust | Ex tc IIIC T90°C Dc Ta= -40°C to +60°C (-20°C to +50°C emergency variants) |
| ABS Certificate | # 23-2432337-PDA |

Electrical

| | 5K | 7.5K | 10K | 12.5K | 15K |
|---------------|--|------|-----|-------|------|
| Input | 110-277V 50/60Hz AC only | | | | |
| Power | 40W | 60W | 80W | 100W | 120W |
| Termination | Incoming terminal block suitable for looping 4 core 4mm ² cable | | | | |
| Power Factor | >0.95 | | | | |
| Cable Entries | 2xM20 as standard (other entries available upon request), dispatched complete with one ATEX/IEC Ex/UKEX approved blanking plug | | | | |

Optical

| | 5K | 7.5K | 10K | 12.5K | 15K |
|-----------------------|--|---------|----------|----------|----------|
| Beam Patterns | 30° x 30° or 60° x 60° or 90° x 90° or 120° x 15° or 10° x 10° | | | | |
| Lumen Output On Mains | 5,486lm | 8,235lm | 10,973lm | 13,712lm | 16,470lm |
| LED Type | Platinum Elite SMT LEDs | | | | |
| Number of LEDs | 24 | 24 | 48 | 48 | 48 |
| CRI | 70+ | | | | |
| Colour Temperature | 5,700K | | | | |

Mechanical

| | 5K | 7.5K | 10K | 12.5K | 15K |
|---------------------------|---|------|-----|-------|-----|
| Burning Position | Universal | | | | |
| IP Rating | IP66 & IP67 | | | | |
| Temperature Range | -40°C to +60°C (-40°F to +140°F) -20°C to +50°C for emergency variants (-4°F to +122°F) | | | | |
| Weight | 13.2kg (29.1lbs) 16kg (35.2lbs) for emergency variant | | | | |
| Enclosure | Marine grade aluminium epoxy powder coated, toughened glass, all external fasteners and brackets are marine grade stainless steel | | | | |
| Unit Colour | Silver (RAL 9006) | | | | |
| Installation Instructions | Please see document 1250-D-00005 at www.rayteclcd.com | | | | |
| Battery Care | Please see document 0010-D-00001 at www.rayteclcd.com | | | | |
| Dimensions | See dimension sketches | | | | |
| Mounting | Stirrup bracket (see dimension sketches) | | | | |

Technical Specifications - Emergency

| Intelligent Emergency | 5K | 7.5K | 10K | 12.5K | 15K |
|-------------------------|---|------|-----|-------|-----|
| Function | Self testing Intelligent Emergency | | | | |
| System Health Indicator | Bi Colour Indicator LED | | | | |
| Emergency Duration | 180 or 90 mins depending on variant Other options available | | | | |
| Emergency Output (upto) | 4941 lumens (90 mins duration) 2120 lumens (180 mins duration) | | | | |
| Emergency Battery | NiMH 12V 6.0Ah | | | | |
| Emergency Charge Time | 20 Hours | | | | |

Product Dimensions

MPFL - Standard

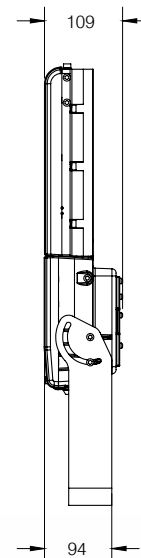
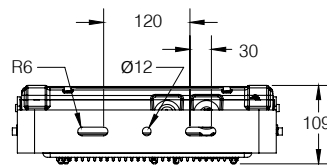
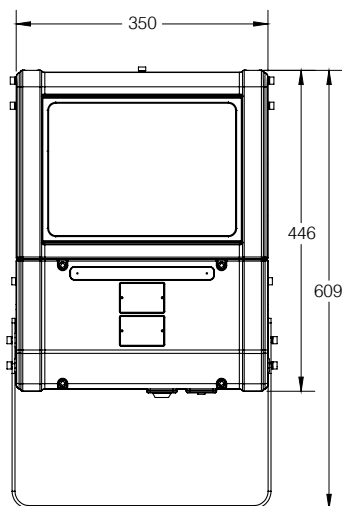

MPFL - Emergency

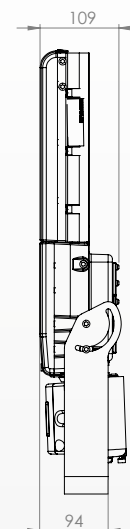
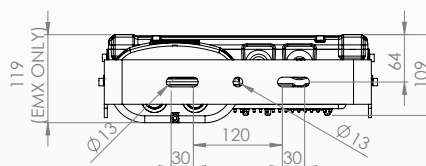
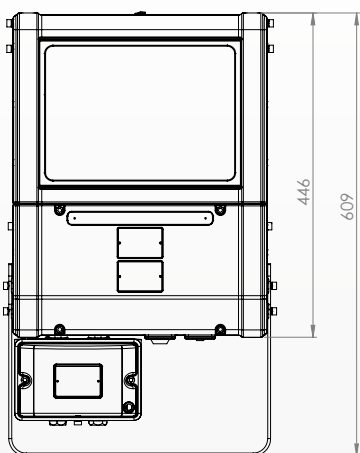

Beam Patterns

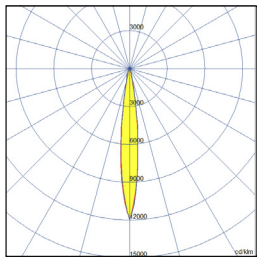

10x10

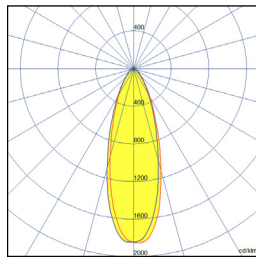

30x30

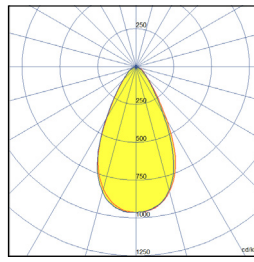

60x60

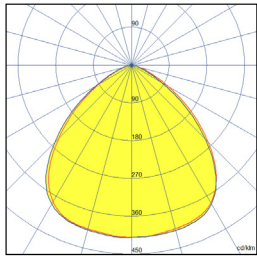

90x90

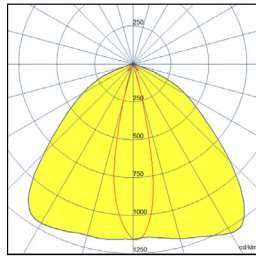

120x15

Part Code Builder

SPARTAN Mid Power Flood

Example - SPZ-MPFL15K-W-9090-EMX90

| Family | Model | Light Type | Optics | Emergency | CCT | Entry |
|--------|----------|----------------|--------|------------------------------|--------------------|------------------|
| SPZ | MPFL5K | W- White Light | 3030 | EMX90 (90 minute duration) | Not Stated - 5700K | Not Stated - M20 |
| | MPFL7K5 | | 6060 | EMX180 (180 minute duration) | 4K - 4000K | M25 |
| | MPFL10K | | 9090 | | | |
| | MPFL12K5 | | 12015 | | | |
| | MPFL15K | | 1010 | | | |

Disclaimer

The information provided in this document was accurate at the time of its creation. However, due to the evolving nature of our products and continuous improvements, there may be changes or updates that occur after its publication.

For the most current and detailed information about our products, please contact our sales team at sales@rayteclcd.com.